

Recessed - Empotrable

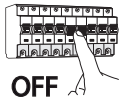

Cut out



2

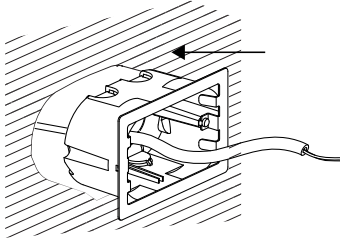

* See recessed box in www.faro.es

3

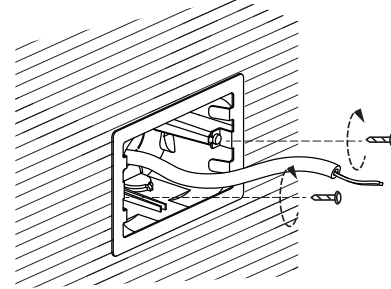

4

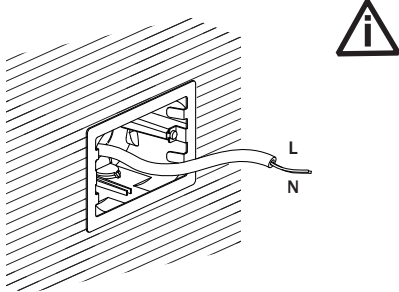

* Wiring connection box NO INCL. See recessed box in www.faro.es

5

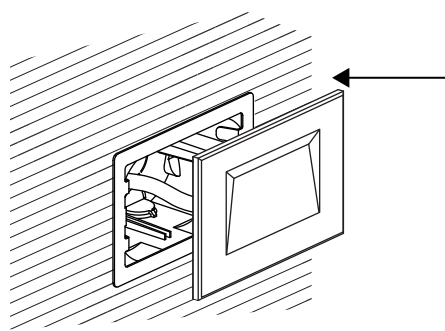

6

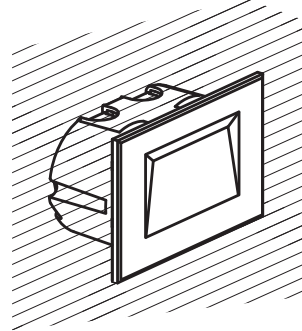

Min IP65 wiring connection box NOT INCLUDED. The installation may need the intervention of a qualified person. The block of connection must comply EN 60998-2-1 or EN 60998-2-2. The block of connection: MAX 10A

Caja de conexión con min IP65 NO INCLUIDA. La instalación puede requerir la intervención de una persona cualificada. El bloque de conexión a incluir debe ser conforme con la EN 60998-2-1 o EN 60998-2-2. Bloque de conexión: MAX 10A

EXAMPLE - EJEMPLO

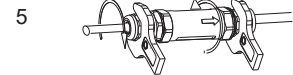
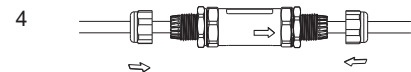
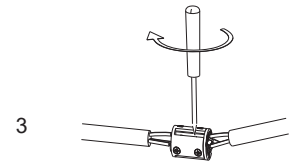
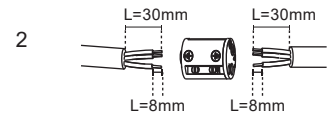
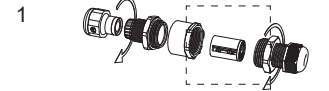
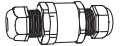

Surface - Aplique

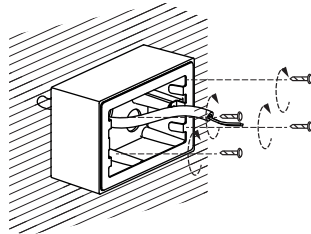
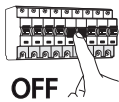

* See surface box in www.faro.es

2

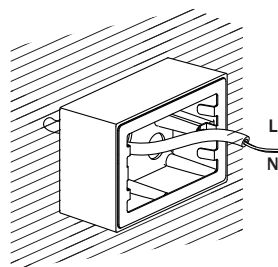

* Wiring connection box NO INCL. See recessed box in www.faro.es

3

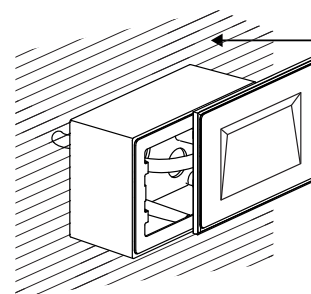

	IP65 IK10	Recessed box NO INCL	0,5m H05RN-F 2x1,0mm ² -Tz

DART-1 3000K (70272N-70273N) **F** This product contains a light source of energy efficiency class F
Este producto contiene una fuente luminosa de la clase eficiencia energética F

DART-2 3000K (70277N-70278N) **D** This product contains a light source of energy efficiency class D
Este producto contiene una fuente luminosa de la clase eficiencia energética D

DART-1 2700K (70272-70273) **G** This product contains a light source of energy efficiency class G
Este producto contiene una fuente luminosa de la clase eficiencia energética G

DART-2 2700K (70277-70278) **F** This product contains a light source of energy efficiency class F
Este producto contiene una fuente luminosa de la clase eficiencia energética F