

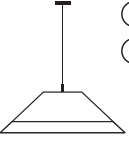

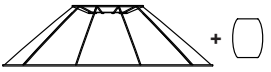

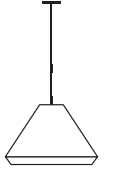
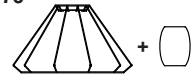
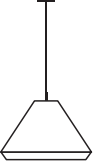
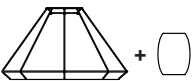

Options

 <input type="radio"/> 71579C-08 brown <input type="radio"/> 71579H-08 brown W100 	 <input type="radio"/> 71579C-07 brown <input type="radio"/> 71579H-07 brown W70 
 <input type="radio"/> 71579C-05 matt white <input type="radio"/> 71579C-06 brown <input type="radio"/> 71579H-05 matt white <input type="radio"/> 71579H-06 brown T70 	 <input type="radio"/> 71579C-04 matt white <input type="radio"/> 71579H-04 matt white R45 
 <input type="radio"/> 71579-02 matt white R55 	 <input type="radio"/> 71579C-03 matt white <input type="radio"/> 71579H-03 matt white R17 

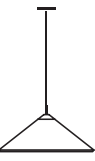

TECHNICAL FEATURES

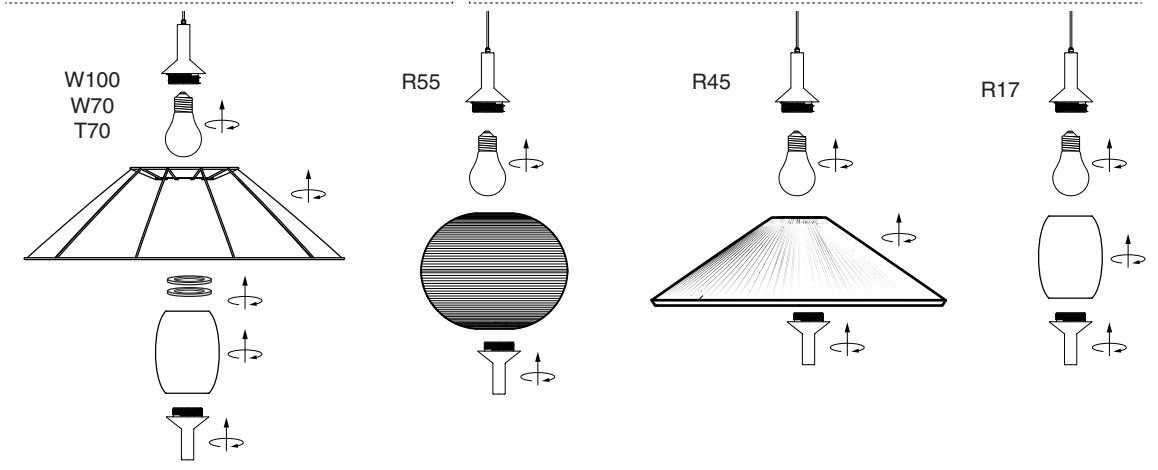
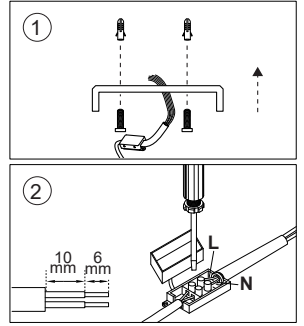
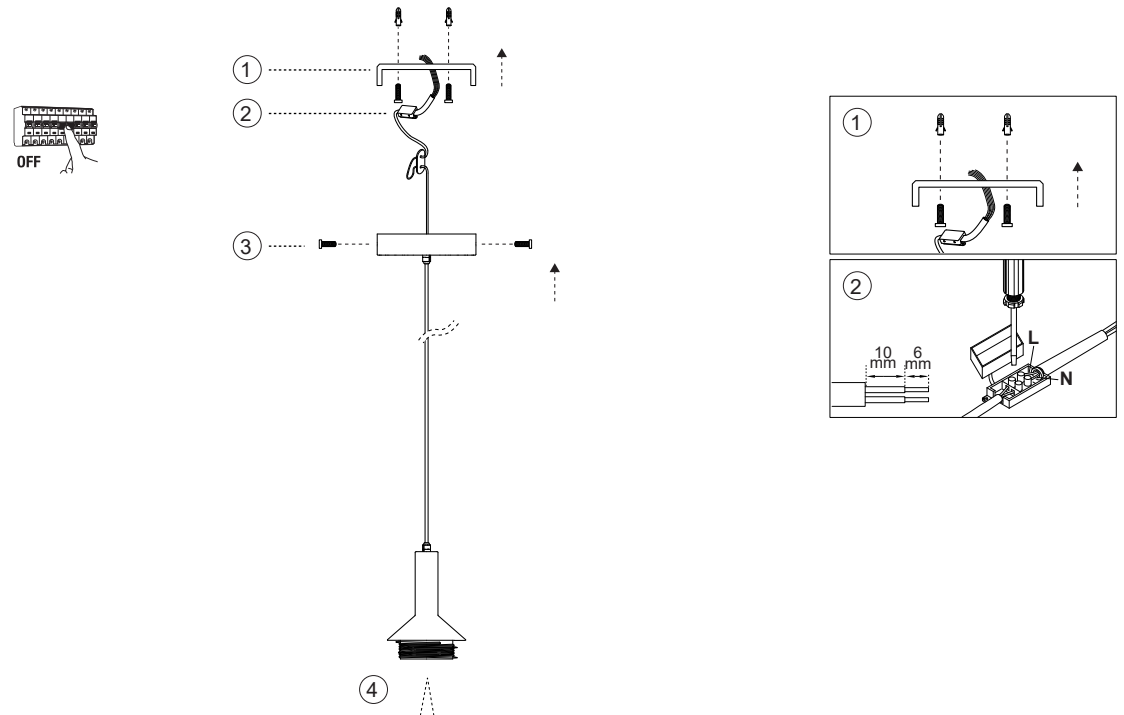
1 X E27 MAX 15W LED no incl.

																
---	---	---	---	---	--	---	---	---	---	---	---	---	---	---	---	---

Together we take care of the planet



Together
we take care
of the planet

Together we take care of the planet.

This is why we reduce paper consumption. Please refer to the safety, maintenance and warranty instructions at www.faro.es. If you cannot access it, call us at +34 937 723 965 or write to export@faro.es.

Juntos cuidamos el planeta. Por eso reducimos el consumo de papel. Puedes consultar las instrucciones de seguridad, mantenimiento y garantía en www.faro.es. Si no puedes acceder, llámanos al +34 902 165 166 o escríbenos a faro@lorefar.com.

Junts cuidem el planeta. Per això reduïm el consum de paper. Pots consultar les instruccions de seguretat, manteniment i garantia en www.faro.es. Si no hi pots accedir, telefona'ns al +34 902 165 166 o escriu-nos a faro@lorefar.com.

Ensemble, nous prenons soin de la planète. C'est pourquoi nous réduisons la consommation de papier. Veuillez-vous référer aux instructions de sécurité, d'entretien et de garantie sur www.faro.es. Si vous ne pouvez pas y accéder, appelez-nous au +34 937 723 965 ou écrivez à export@faro.es.

Insieme proteggiamo il pianeta.

Questo è il motivo per il quale abbiamo ridotto il consumo di carta. Per favore, leggi le istruzioni sulla sicurezza, la manutenzione e la garanzia sul sito www.faro.es. Se non puoi accedere, chiamaci al +34 937 723 965 o scrivici a export@faro.es.

Juntos cuidamos do planeta. É por este motivo que reduzimos o consumo de papel. Consulte as instruções de segurança, manutenção e garantia em www.faro.es. Se não conseguir aceder, ligue para +34 937 723 965 ou escreva para export@faro.es.

Gemeinsam sorgen wir uns um unseren Planeten. Deshalb reduzieren wir den Papierverbrauch. Bitte beachten Sie die Sicherheits-, Wartungs- und Garantiehinweise unter www.faro.es. Wenn Sie nicht darauf zugreifen können, rufen Sie uns unter +34 937 723 965 an oder schreiben Sie an export@faro.es.

We dragen samen zorg voor onze planeet. Daarom verminderen wij het papiergebruik. Raadpleeg de veiligheids-, onderhouds- en garantiehandleiding op www.faro.es. Kan u ze niet raadplegen? Bel ons op +34 937 723 965 of schrijf ons op export@faro.es.

Μαζί φροντίζουμε τον πλανήτη. Για αυτόν τον λόγο μειώνουμε την κατανάλωση χαρτί. Παρακαλούμε, ανατρέξτε στις οδηγίες ασφαλείας, συντήρησης και εγγύησης στην ιστοσελίδα www.faro.es. Αν δεν μπορείτε να αποκτήσετε πρόσβαση, τηλεφωνήστε μας στο +34 937 723 965 ή γράψτε μας στο export@faro.es.

Вместе мы заботимся о планете.

Вот почему мы сокращаем потребление бумаги. Пожалуйста, обратитесь к инструкциям по безопасности, техническому обслуживанию и гарантии на сайте www.faro.es. Если вы не можете получить к нему доступ, позвоните нам по телефону +34 937 723 965 или напишите на export@faro.es.

Společně pečujeme o planetu.

Proto omezujeme spotřebu papíru. Přečtěte si, prosím, pokyny týkající se bezpečnosti, údržby a záruky na www.faro.es. Pokud na stránky nemáte přístup, zavolejte nám na tel. +34 937 723 965 nebo napište na export@faro.es.

Razem dbamy o planetę. Dlatego zmniejszamy zużycie papieru. Proszę zapoznać się z instrukcjami bezpieczeństwa, konserwacji i gwarancji na www.faro.es. Jeśli nie możesz uzyskać do niego dostępu, zadzwoń do nas pod numer +34 937 723 965 lub napisz na adres export@faro.es.

Заедно ние се грижим за планетата. Ето защо намаляваме консумацията на хартия. Моля, направете справка с инструкциите за безопасност, поддръжка и гаранция на www.faro.es. Ако нямате достъп до сайта, обадете ни се на +34 937 723 965 или пишете на export@faro.es.

Spoločne sme sa postarar' o tejto planéte.

To je dôvod, prečo sme znížili spotrebu papiera. Pozri pokyny k bezpečnosti, údržby a záruky na www.faro.es. Ak nemôžete prístupovať, zavolajte na telefónne číslo +34 937 723 965 alebo píšete n export@faro.es.

معا نعتني بالكوكب.

هذا هو السبب في تقليل استهلاك الورق.

يرجى الرجوع إلى تعليمات السلامة

والصيانة والضمان على www.faro.es

إذا لم تتمكن من الولوج إليه، اتصل بنا

على +34 937 723 965 أو اكتب رسالة

إلى export@faro.es