



TALAN M, IP44, 27/30/4000K  
TALAN M, IP44, 27/30/4000K



48502

MONTAGE- UND BETRIEBSANLEITUNG  
MOUNTING AND OPERATING INSTRUCTIONS

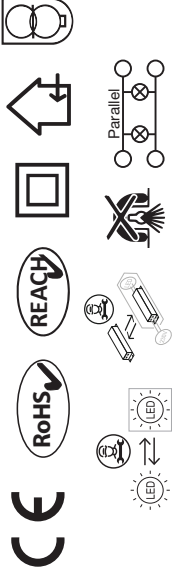
TALANM\_IP44\_27/30/4000K\_BA\_48502\_01/2024





**SICHERHEITSHINWEISE:**

-  **Stromschlaggefahr!**  
Beauftragen Sie mit der Installation eine Elektrofachkraft. Für Strahler, die nicht gemäß den europäischen Sicherheitsrichtlinien installiert wurden, entfällt jeder Haftungsanspruch.
-  **Brandgefahr!**  
Strahler nicht mit wärmedämmenden Stoffen abdecken.
-  **Achtung!**  
Für alle Anschlüsse sekundärseitig des Konverters ist ausschließlich die mitgelieferte Niedervoltleitung zu verwenden.  
Der Strahler ist zur Montage in normal entflammbaren Oberflächen geeignet, z.B. auf Holz und Werkstoffen auf Holzbasis mit mehr als 2 mm Stärke. Strahler nur nach unten strahlend montieren.

**HINWEIS:**

Dieses Produkt enthält eine Lichtquelle der Energieeffizienzklasse E.

**SYMBOLLE ALLGEMEIN:**

-  CE-konform mit den zutreffenden europäischen Richtlinien.
-  RoHS-Prüfzeichen für Produkte, die keine Schwermetalle beinhalten (2011/65/EU).
-  REACH-Prüfzeichen für Produkte, deren chemische Bestandteile bekannt, registriert und zugelassen sind. (1907/2006/EG).



Parallelanschluss:  
Für die Durchgangsverdrahtung geeignet.



Nur für den Innenbereich geeignet.

**SYMBOLLE KONVERTER:**



Schutzklasse II





Kurzschlussfest



Betriebsgerät austauschbar durch Elektrofachkraft.

**SYMBOLLE STRAHLER:**

-  LED-Leuchte oder Betriebsgerät nicht mit Wärmedämmenden Stoffen abdecken.
-  LED-Lichtquelle austauschbar durch Elektrofachkraft.

**EINBAU MIT HALTEFEEDERN:**

Die Haltefedern müssen nach der Installation in horizontaler Position liegen, nicht vertikal (Abb. 1).





Abb. 1

**DREI WEGESCHALTER EINSTELLUNG:**

LEISTUNG		LICHTFARBE	
	225 mA 340 mA 450 mA		UWW WW NW
9 W	14 W 18 W	2700K	3000K 4000K

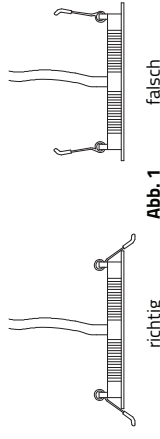
**NETZGERÄTE PRO LEITUNGSSCHUTZSCHALTER:**

LS	B10	B16	B25	C10	C16	C25
Stk.	38	61	95	54	87	136

**TECHNISCHE DATEN:**

**Eingang:**  
220 - 240 V AC, 50/60 Hz

**Ausgang:**  
9/14/18 W max.

**Umgebungstemperatur:**  
-10 bis +40 ° C

**NOTIZEN:  
NOTES:**

Lined area for notes.



**TECHNISCHE  
PRODUKTABMESSUNGEN:**

**Einbaustrahler:**  
Außendurchmesser:  $\varnothing$  220 mm  
Einbaudurchmesser:  $\varnothing$  210 mm  
Höhe: 18 mm  
Einbautiefe: 30 mm

**Konverter (L x B x H):**  
113,5 x 35,5 x 23,5 mm

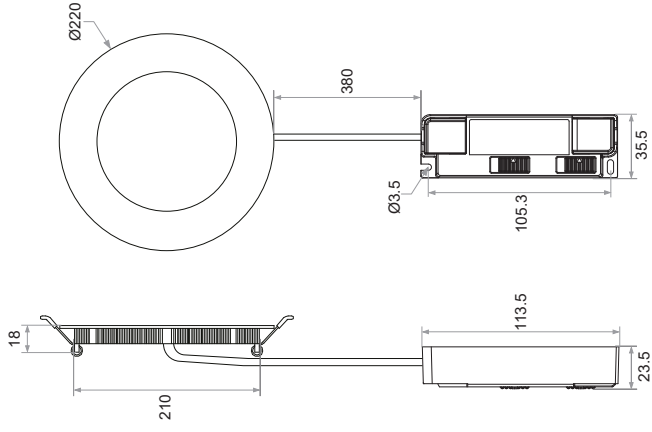

Der TALAN Konverter des Artikels 48502 ist ein primärseitig nicht dimmbarer Konverter, welcher auf der Sekundärseite einen gleichgerichteten konstant Strom von 225/340/450 mA und eine Leistung von 9/14/18 W ausgibt.

**MONTAGE:**



**Stromschlaggefahr!**

Vor der Installation Spannung abschalten. Sicherstellen, dass die Spannung nicht versehentlich wieder eingeschaltet werden kann.

1. Loch am Montageort sägen. Der Einbaudurchmesser beträgt 210 mm.



2. An die Primärseite des Konverters die vorhandene 230 V AC Netzspannung anschließen (Abb. 2).

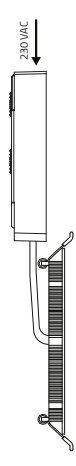

**Abb. 2**

3. Spannen Sie die Federn des Einbaustrahlers ① und setzen ihn den vorbereiteten Deckenausschnitt ein. ② (Abb. 3).

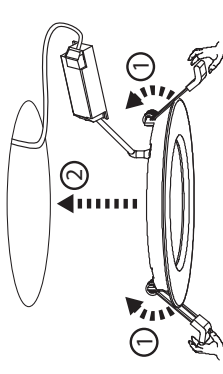

**Abb. 3**

**INBETRIEBNAHME:**

- Betreiben Sie den Schutzklasse III Einbaustrahler TALAN ausschließlich an dem dafür vorgesehenen Konstantstrom-Konverter (im Lieferumfang enthalten).
- Überprüfen Sie ob die Eingangs- und Ausgangsleitungen korrekt angeschlossen worden sind, bevor Sie die Spannung zuschalten um das Produkt in Betrieb zu nehmen.

**ENTSORGUNG:**



Entsorgen Sie elektrische und elektronische Geräte umweltgerecht. Nähere Informationen erhalten Sie bei Ihrer zuständigen Behörde.

**SAFETY INSTRUCTIONS:**



**Risk of electric shock!**  
Be sure to have a professional electrician complete installation. There is no warranty coverage for any lamps installed without observing European safety directives.



Do not cover lamps with heat-insulating materials.



Only the supplied low voltage cable must be used for all connections on the secondary side of the converter.

The Downlight is suitable for mounting on normally flammable surfaces such as wood and particle board materials which are more than 2 mm thick. Only install downlights so that they shine downwards.

**NOTICE:**

This product contains a light source of energy efficiency class E.

**SYMBOLS IN GENERAL:**



Compliant with the applicable European CE directives.



RoHS mark for products that do not contain heavy metals (EC Directive 2002/95/EC).



REACH test mark for products whose chemical components are known, registered and authorised.



Parallel circuit:  
Suitable for through-wiring.



Suitable for indoor use only.

**SYMBOLS LED KONVERTER:**



Protection class II



Short-circuit proof



LED control gear can be replaced by a qualified electrician.

**SYMBOLS LED DOWNLIGHT:**



Do not cover the LED luminaire or control gear with heat-insulating materials.



LED light source can be replaced by a qualified electrician

**INSTALLATION OF MOUNTING SPRINGS:**

Make sure that the springs are in the right position (fig. 1).

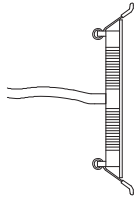

fig. 1

**TECHNICAL PRODUCT DIMENSIONS:**

**LED Downlight:**

outer diameter:  $\varnothing$  220 mm  
inner diameter:  $\varnothing$  210 mm  
height: 18 mm  
installation depth: 30 mm

**Converter (L x W x H):**

113.5 x 35.5 x 23.5 mm

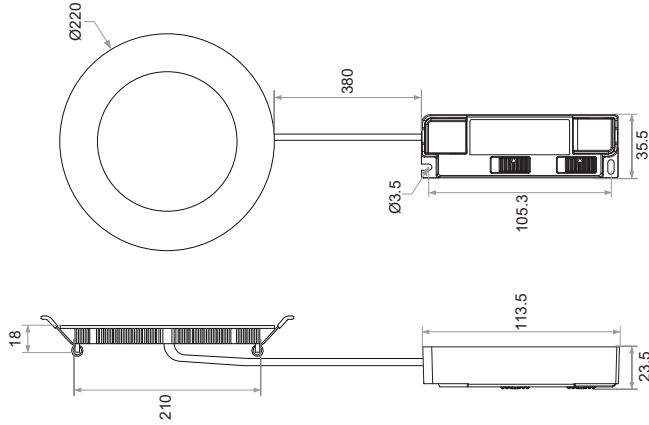

**SLIDE SWITCH ADJUSTMENTS:**

LOAD	225 mA	340 mA	450 mA
9 W	14 W	18 W	

LIGHT COLOUR	UWW	WW	NW
2700K	3000K	4000K	

**POWER SUPPLY UNITS PER CIRCUIT BREAKER:**

CBR	B10	B16	B25	C10	C16	C25
Pcs.	38	61	95	54	87	136

**TECHNICAL DATA:**

**Input:**  
220 - 240 V AC, 50/60 Hz

**Output:**  
9/14/18 W max.

**Ambient temperature:**  
-10 bis +40 ° C

The LED converter of the TALAN 48502 is a non-dimmable converter on the primary side, which provides a rectified constant current of 225/340/450 mA and a maximum power of 9/14/18 W on the secondary side.

**MOUNTING:**



**Risk of electric shock!**

Switch off voltage prior to installation. Ensure that voltage cannot be accidentally switched on again.

1. Saw a hole at the installation location. The diameter is 210 mm.
2. Connect the TALAN recessed downlight to the secondary side line of the converter using the connector supplied with the matching counterpart of the connector. Connect the existing 230 V AC mains voltage to the primary side of the converter (fig. 2).

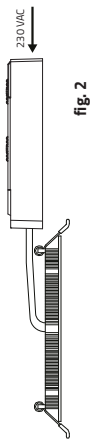

fig. 2

3. Tension the springs of the recessed downlight ① and insert it into the prepared ceiling cut-out ② (fig. 3).

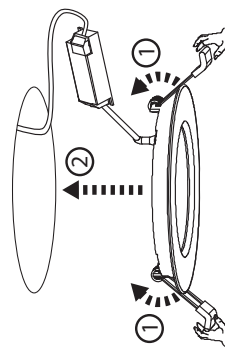

fig. 3

**INSTALLATION:**

- Only operate the protection class II recessed downlight TALAN with the constant Current converter provided for it (including in delivery).
- Check that the input and output cables have been connected correctly before switching on the power to operate the product.

**DISPOSAL:**



Dispose of electrical and electronic equipment in an environmentally sound manner. For more information, contact your local authority.