

SIRRO 2.0

INSTALLATION INSTRUCTIONS | FEBRUARY 2023

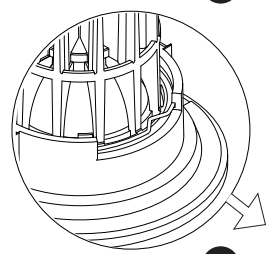
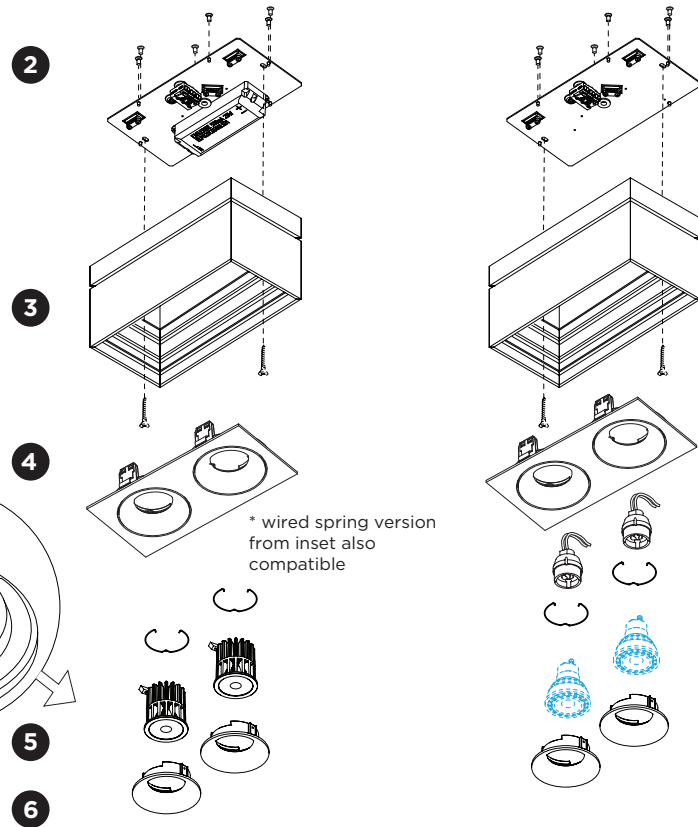

* wired spring version from inset also compatible

back plate dimensions

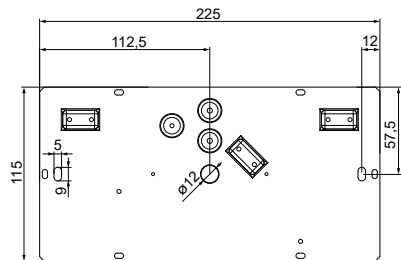

⚠ Before connecting the luminaire/LED module to the driver please make sure the driver is **not** powered but disconnected from the mains. The driver can only be powered when the luminaire/LED module is already connected. Disregarding this instruction might damage or even destroy the luminaire/LED module.

Driver must be powered off before connecting the cables.

DIMENSIONS

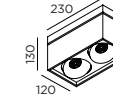

MOUNTING INSTRUCTION

1 POWER CONNECTION

Single connection - for LED and PAR16



Multiple connection - for LED and PAR16

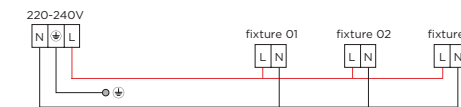

- 2 Attach the back plate to the cover with the 6 screws.
- 3 Mount the back plate on the ceiling with screws (screws are not included).
- 4 Insert the outer part of the inset module into the cover.
- 5 Insert the bulbs or LED engines into the inner parts of the inset module by mounting the springs from the backside.
- 6 Connect the bulbs or LED engines and click the inner part of the inset module into the outer part.

SIRRO 2.0

INSTALLATION INSTRUCTIONS | FEBRUARY 2023

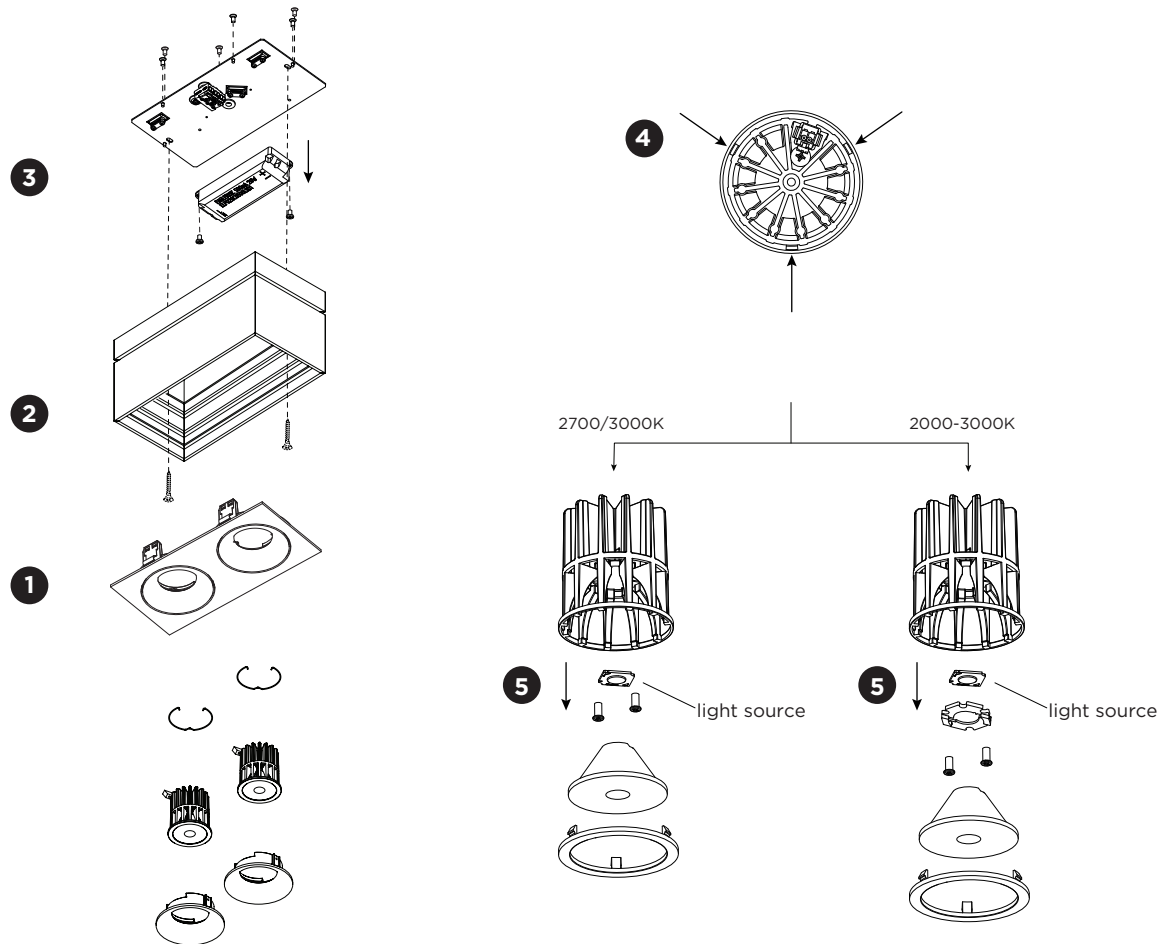

DISMANTLING AND RECYCLING INSTRUCTIONS *only for 1.0 LED* Light source & driver

- 1 Take out the LED module(s) by pushing in the LED engine, pulling out the inner part of the inset and disconnecting the connector.
- 2 Dismount the backplate from the ceiling and unscrew the cover.
- 3 Remove the screws and disconnect the wires to remove the driver.
- 4 Push at the three points to loosen the front ring.
- 5 Take the lens(es) out and unscrew the light source(s) or holder(s) to remove the light source(s).



The light source is replaceable by an authorized professional.
For advice contact your Wever & Ducré customer service contact point.

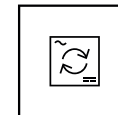

The driver can be replaced by the end user.



This luminaire contains a light source with the energy class D.