

# DEEP BIJOU

INSTALLATION INSTRUCTIONS | FEBRUARY 2023

1.0 LED

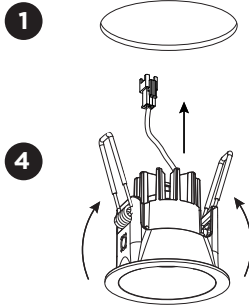

2.0 LED

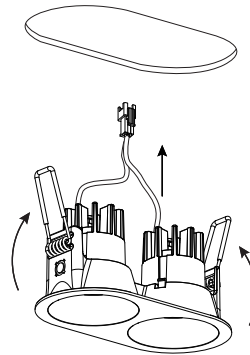

hole dimension

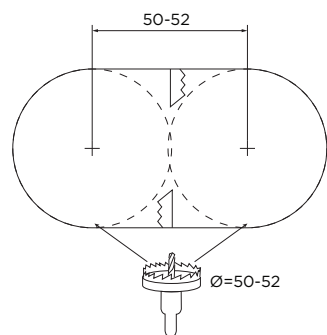

Driver must be powered off before connecting the cables.

Before connecting the luminaire/LED module to the driver please make sure the driver is not powered but disconnected from the mains. The driver can only be powered when the luminaire/LED module is already connected. Disregarding this instruction might damage or even destroy the luminaire/LED module.

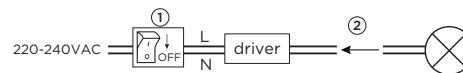

## DIMENSIONS

1.0 LED  
with wire springs



50-52

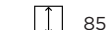

85

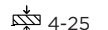

4-25

1.0 LED  
with blade springs



50-52

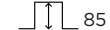

85



Min. 4

2.0 LED

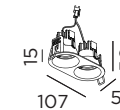

50-52x  
100-104



60

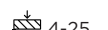

4-25

## MOUNTING INSTRUCTION

- 1 Make a hole in the ceiling according to the prescribed dimensions.
- 2 **POWER CONNECTION**  
Always use a driver according to the specifications of the LED module.

### Single Connection

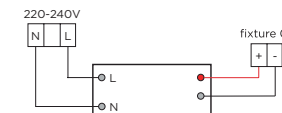

### Multiple Connection

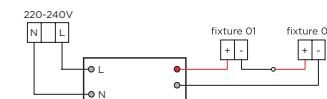

- 3 For wire springs:  
Push the springs upwards and insert the fixture in the ceiling hole.  
For blade springs:  
Push the springs towards the fixture when inserting the fixture in the ceiling hole.

# DEEP BIJOU

INSTALLATION INSTRUCTIONS | FEBRUARY 2023

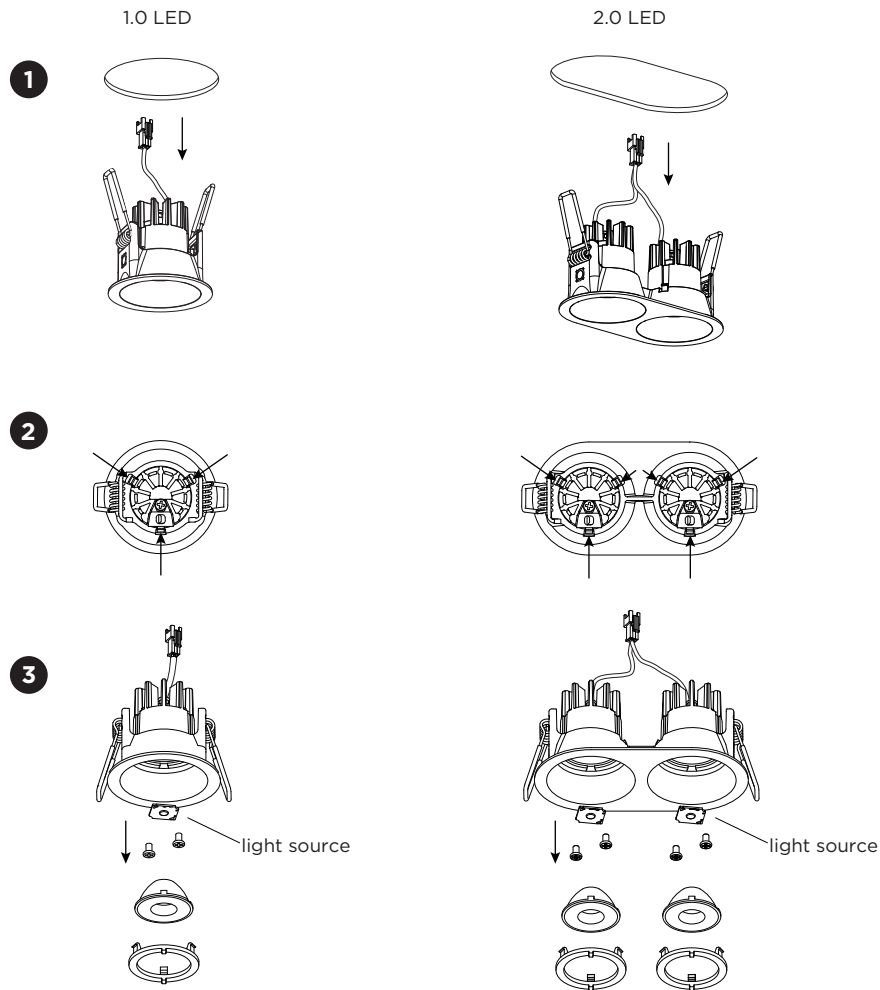

## DISMOUNTING AND RECYCLING INSTRUCTIONS

Light source

- 1 Remove the fixture from the ceiling and disconnect the wires.
- 2 Push at the three points to loosen the front ring(s).
- 3 Take the lens(es) out and unscrew the holder(s) or light source(s) to remove the light source(s).



The light source is replaceable by an authorized professional.  
For advice contact your Wever & Ducré customer service contact point.



This luminaire contains a light source with the energy class D.