

TRACE SPIN CEILING SURFACE

INSTALLATION INSTRUCTIONS | JANUARY 2024

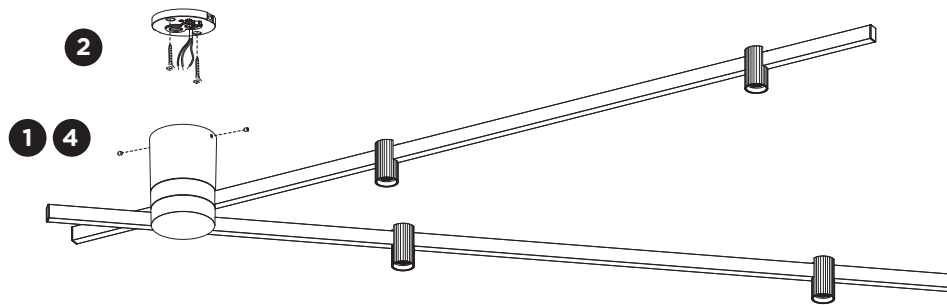

rotation angle:

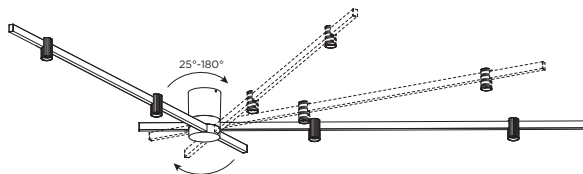

mounting base:

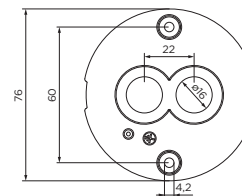

DIMENSIONS

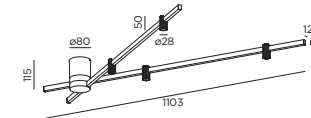

MOUNTING INSTRUCTION

- 1 Remove the mounting base from the luminaire by loosening the socket screws.
- 2 Mount it on the ceiling with screws (screws are not included).
- 3 **POWER CONNECTION**
Connect to 220-240V.

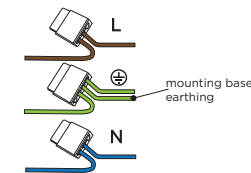

Connect the earth cable.



- 4 Fix the luminaire on the base with the socket screws.

TRACE SPIN CEILING SURFACE

INSTALLATION INSTRUCTIONS | JANUARY 2024

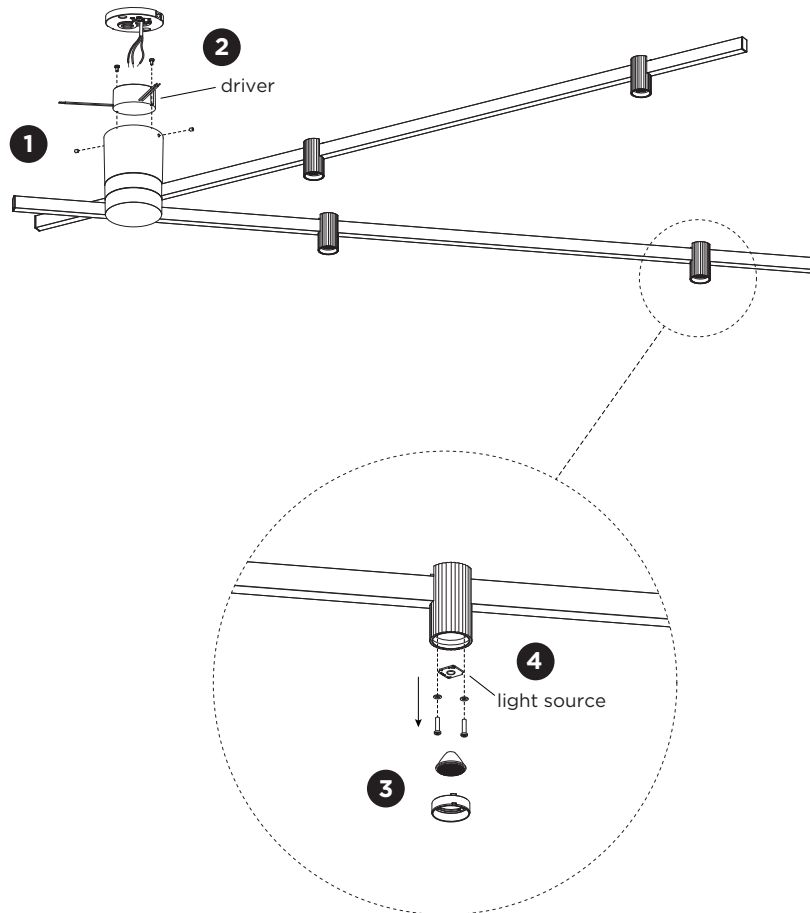

DISMOUNTING AND RECYCLING INSTRUCTIONS

Light source & driver

- 1** Loosen the socket screws from the fixture to remove it from the mounting base.
- 2** Unscrew the driver and disconnect the wires to remove the driver.
- 3** Take out the snoot(s) and remove the lens(es).
- 4** Unscrew the light source(s) to remove it/them.

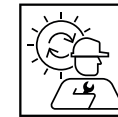

The light source is replaceable by Wever & Ducré or by a professional with explicit authorisation. For more information please contact your local Wever & Ducré customer service point.

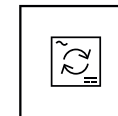

The driver can be replaced by the end user.



This luminaire contains a light source with the energy class E.