

MATCH FLOOR

INSTALLATION INSTRUCTIONS | FEBRUARY 2024

rotation angle:

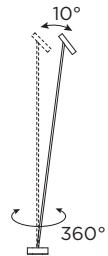

tilt angle:

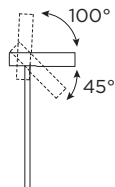

1

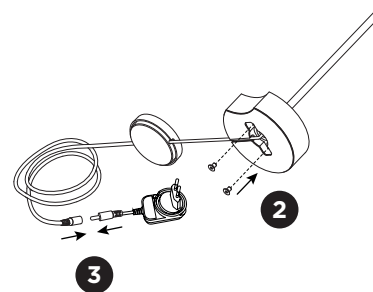
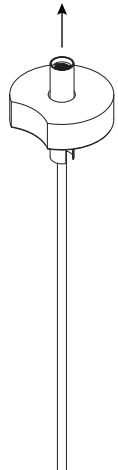

3

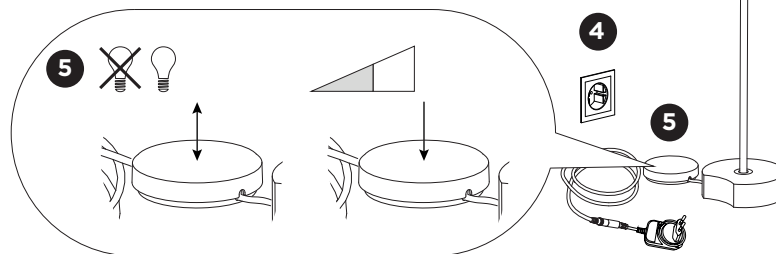

4

5

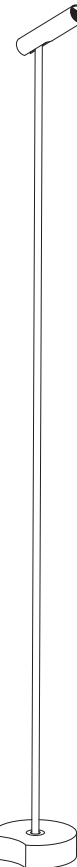

DIMENSIONS

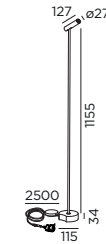

MOUNTING INSTRUCTION

- 1 Pass the fixture through the base.
- 2 Fix it with two screws from the bottom (screws are included).
- 3 Connect the cable with the plug.
- 4 Connect the power cable to the socket.
- 5 Push the button to turn the light on/off.
Hold the button to dim the light.



WEVER & DUCRÉ
LIGHTING

WEVER & DUCRÉ BV
Spinnerijstraat 99/21, 8500 Kortrijk, Belgium
weverducre.com

MATCH FLOOR

INSTALLATION INSTRUCTIONS | FEBRUARY 2024

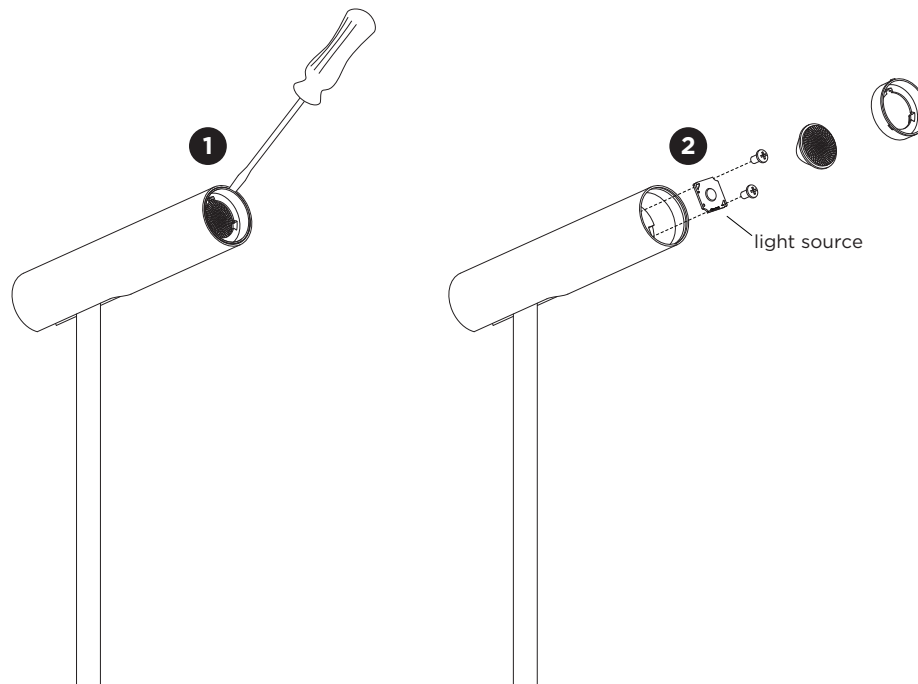

DISMOUNTING AND RECYCLING INSTRUCTIONS

Light source

- 1 Pull out the snout with a flat screw driver.
- 2 Remove the lens, disconnect the wires and remove the light source by unscrewing it.



The light source is replaceable by Wever & Ducré or by a professional with explicit authorisation. For more information please contact your local Wever & Ducré customer service point.



This luminaire contains a light source with the energy class E.